

Article number: 12348000140500
Description: KLEE-coil 348 000 140.500
M 14 St. steel 1.4305

Measures

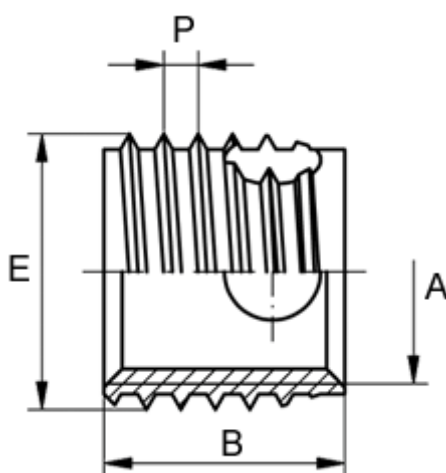

Female thread A	= M14
Length B	= 24
Male thread E	= 16.0
Min hole depth blind hole	= 28
Pre-drilled max	= 15.4
Pre-drilled min	= 15.1
Thread pitch P	= 2.00
Type	= 348 000 140 ...